

CODE
F4000

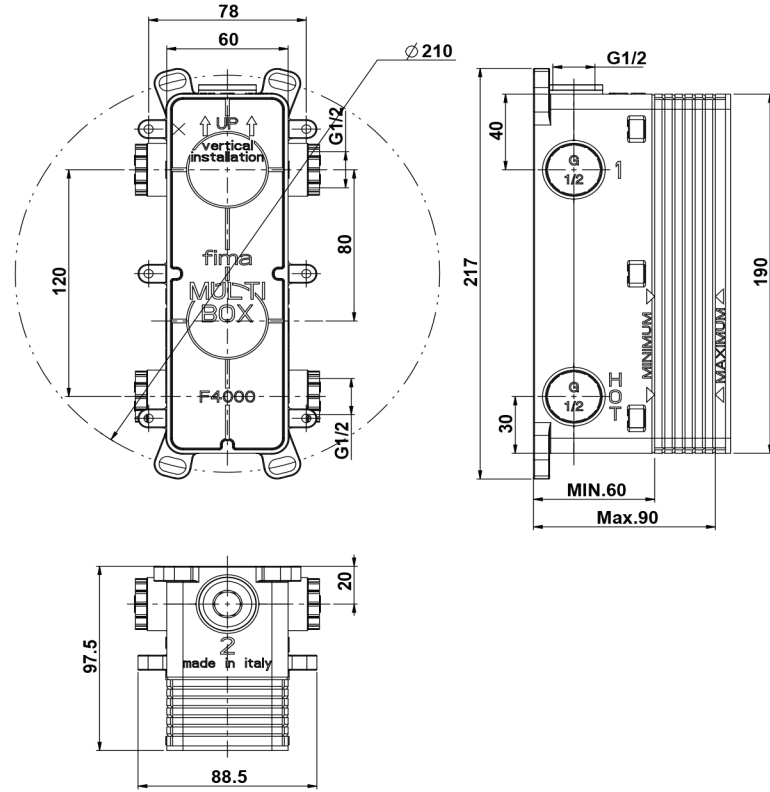

TECHNICAL SPECIFICATIONS •



..... **2-3** OUTLETS



..... UNIVERSAL FOR ALL COLLECTIONS



..... EASY INSTALLATION



..... DOES NOT TRANSMIT VIBRATIONS



..... WATERPROOF



..... DZR BRASS









MECHANICAL



THERMOSTATIC

COMPATIBLE TO EITHER EXTERNAL MECHANICAL OR THERMOSTATIC SHOWER MIXERS

MECHANICAL EXTERNAL PARTS

| | | | | | |
|---|---|---|---|---|---|
|  |  |  |  |  |  |
| SO F3189X6CR | TEXTURE COLLECTION F5609X6HCR F5609X6VCR F5609X6XCR | NOMOS GO F4169X6CR | ZETA F3969X6CR | QUAD F3729X6CR | SPILLO TECH F3039X6GCR F3039X6VCR F3039X6XCR |
|  |  |  |  |  |  |
| SPILLO UP F3039X6CR | SPILLO STEEL F3079X6INOX | FIT F3389X6CR | NEXT F3939X6CR F3949X6CR | MAST F3139X6CR | MAXIMA F5309X6CR |
|  |  |  |  |  |  |
| ELIZABETH F5089X6CR | ELIZABETH CHIC F5089X6CCR | HEREND F5409X6CR | HEREND CHIC F5409X6CCR | LAMP F3309X6CR | BELL F3369X6CR |
|  |  |  |  |  |  |
| SERIE 4 F3769X6CR | SERIE 22 F3839X6CR | SERIE 4 F3009X6CR | SERIE 22 F3009X6CR | SERIE 4 F3009X6CR | SERIE 22 F3009X6CR |

THERMOSTATIC EXTERNAL PARTS

| | | | | | | | | |
|---|---|---|---|---|---|---|---|---|
|  |  |  |  |  |  |  |  |  |
| SO F3189X7CR | TEXTURE COLLECTION SPILLO TECH F5609X7GCR F5609X7HCR F5609X7VCR F5609X7XCR | F3229X7CR | F3239X7CR | F3939X7CR | F3509X7CR | F5009X7CR | F5089X7CR | F5089X7CCR |

60MM

INSTALLATION DEPTH TOLERANCE

30MM

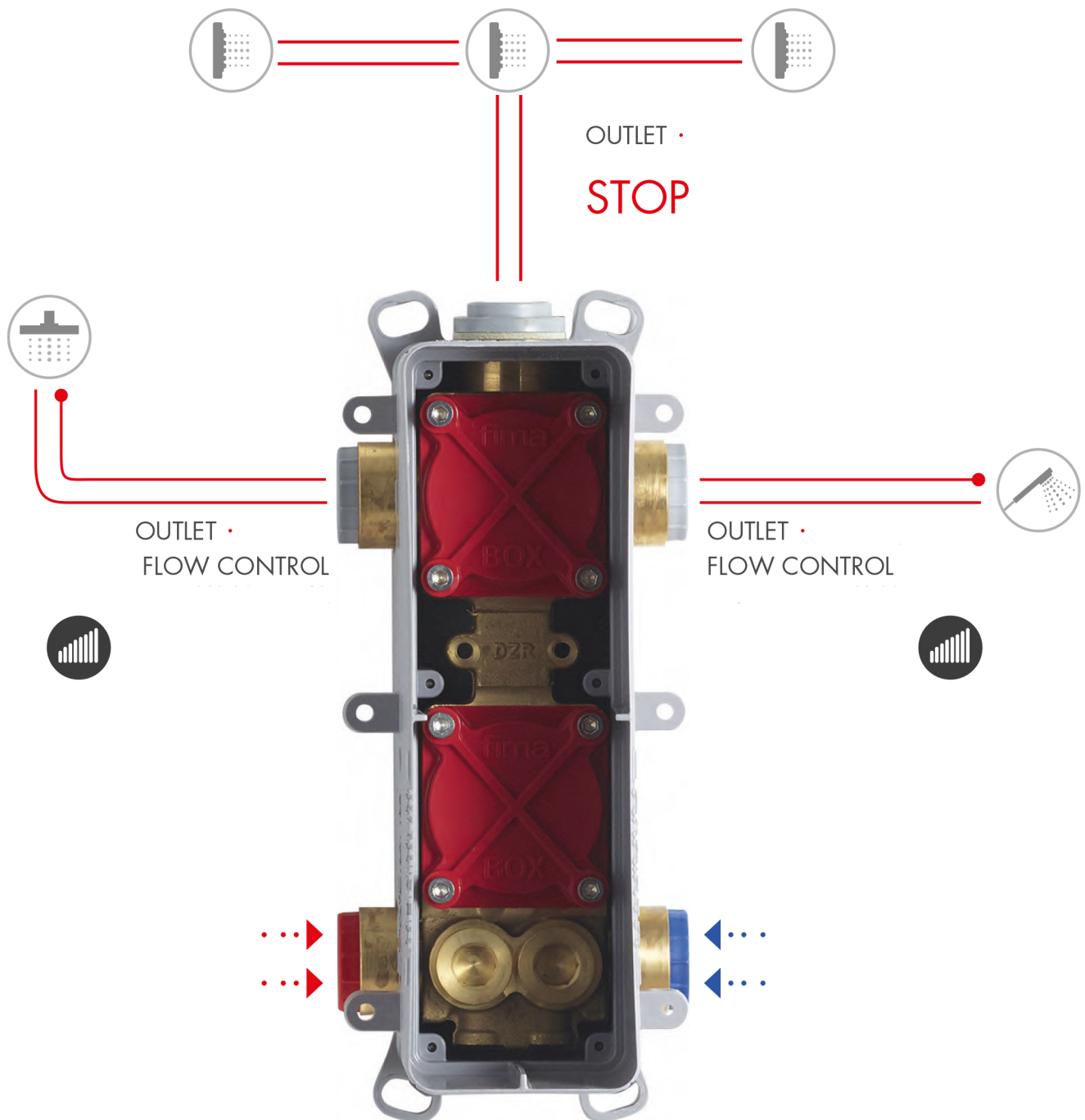

15 MM EXTENSIONS

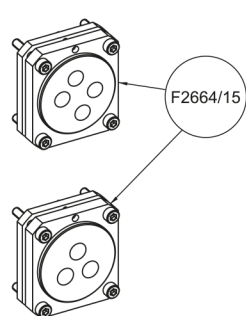

F2664/15

30 MM EXTENSIONS

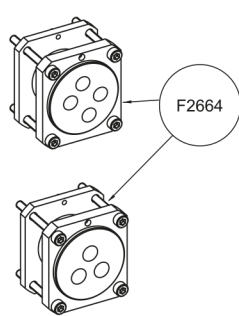

F2664

WATER FLOW | НАПОР ВОДЫ

STANDARD CARTRIDGE Ø35

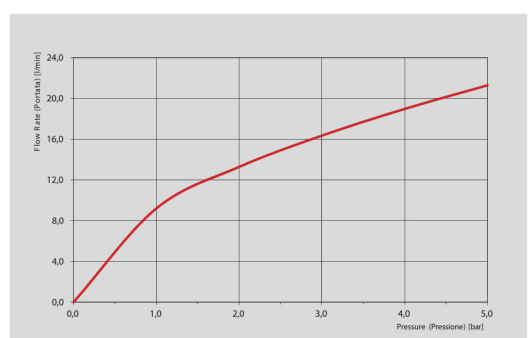

THERMOSTATIC CARTRIDGE Ø42

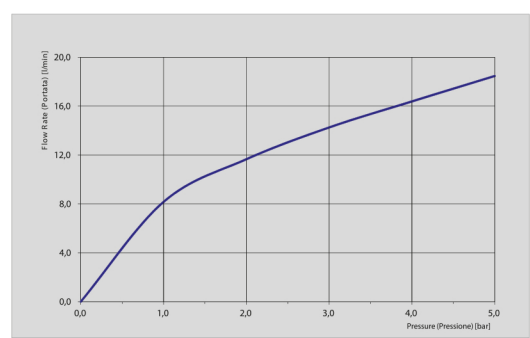

STANDARD CARTRIDGE Ø42

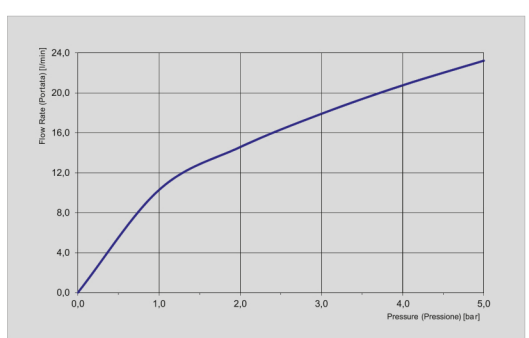

INOX COVERPLATE

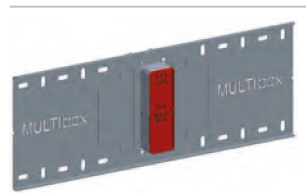

F2539